

**LOT 69**  
24 PORT WAY, HINGAIA

**First Floor Area - 93m<sup>2</sup>**  
**Ground Floor Area - 110m<sup>2</sup>**  
**Overall Area - 203m<sup>2</sup>**  
**Site Area - 330m<sup>2</sup>**

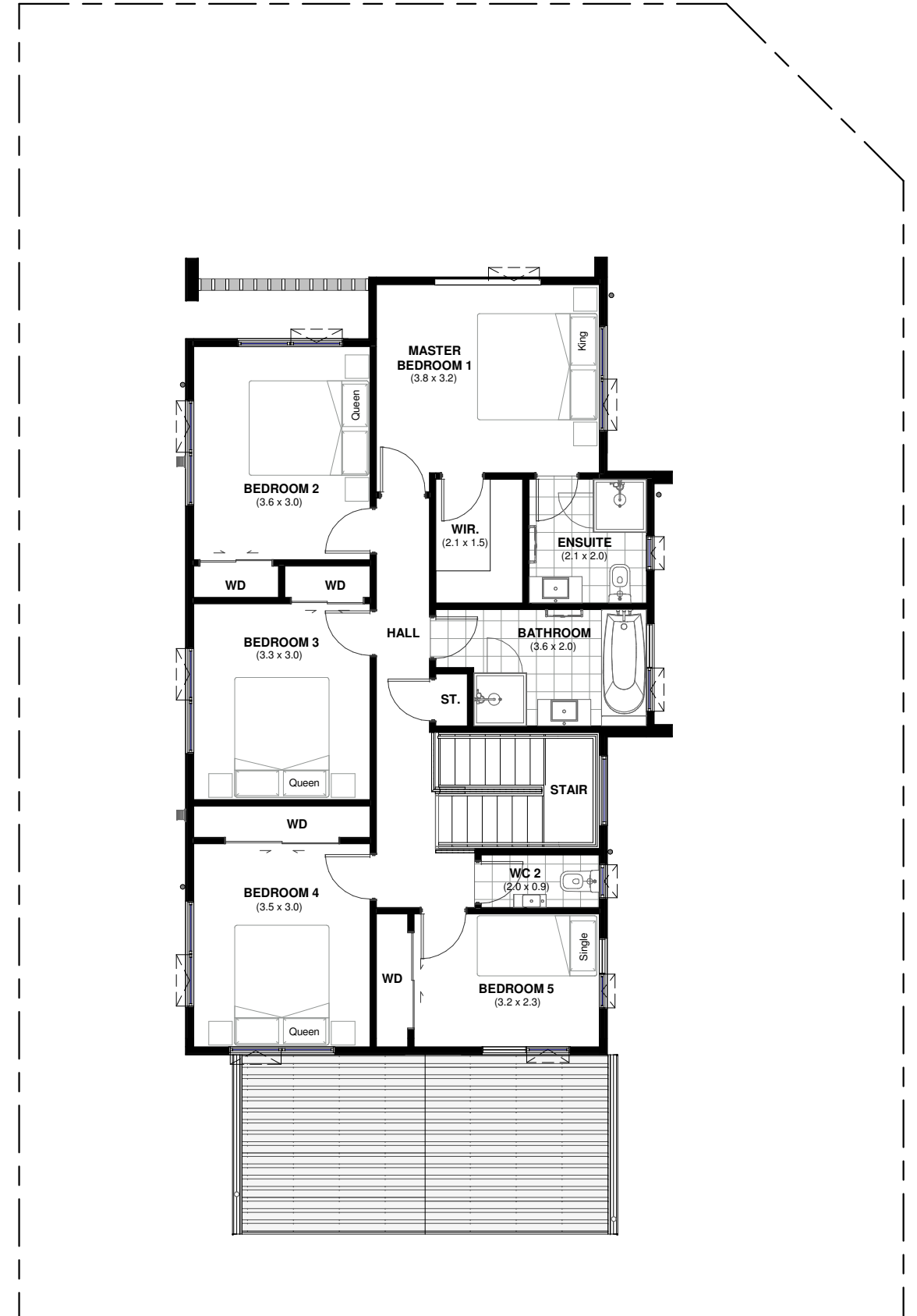

PLANS MAY BE SUBJECT TO CHANGE.  
FLOOR AREAS INDICATED IS APPROXIMATE ONLY

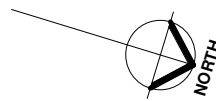
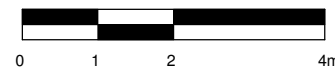
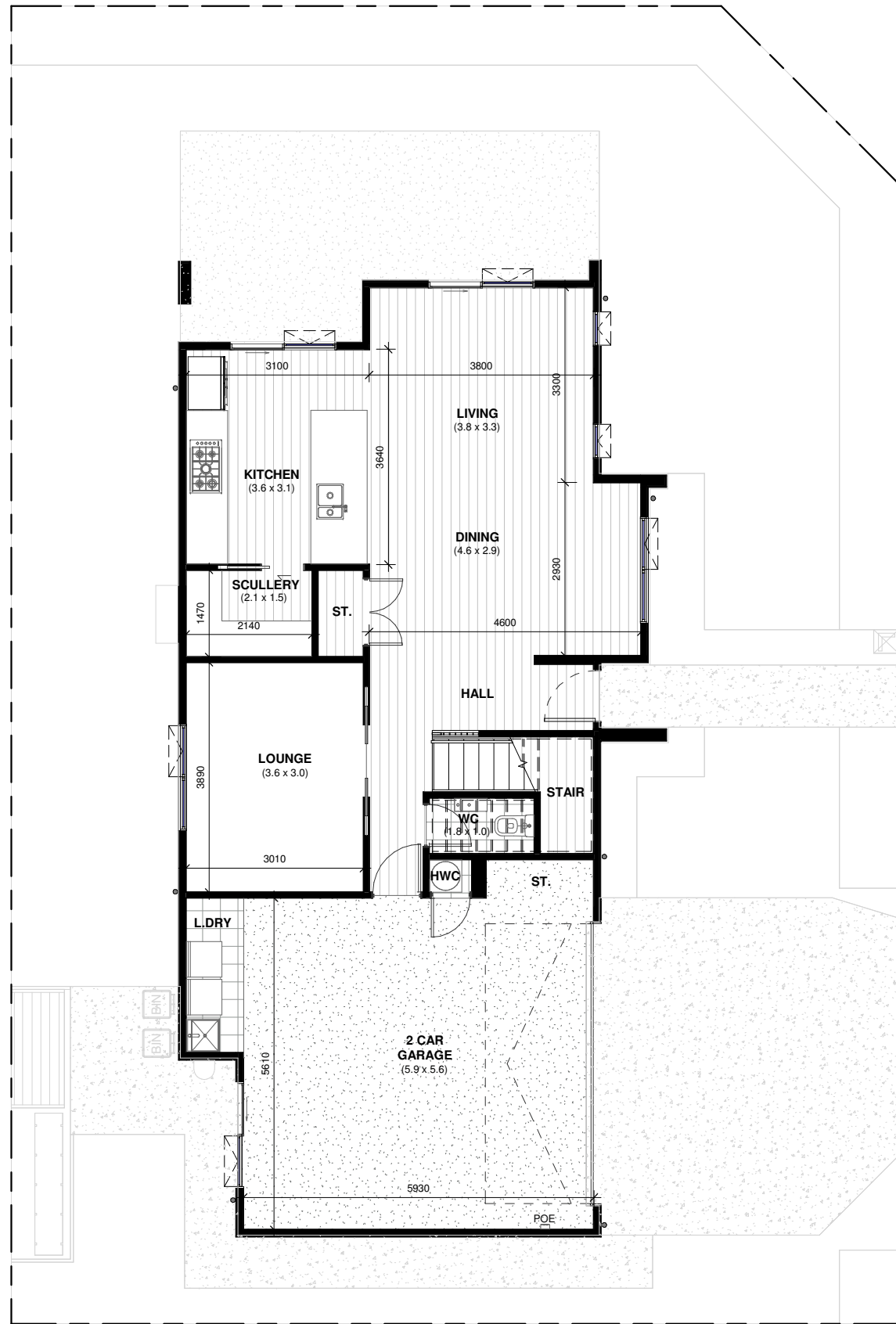

**LOT 69**  
24 PORT WAY, HINGAIA

**First Floor Area - 93m<sup>2</sup>**  
**Ground Floor Area - 110m<sup>2</sup>**  
**Overall Area - 203m<sup>2</sup>**  
**Site Area - 330m<sup>2</sup>**

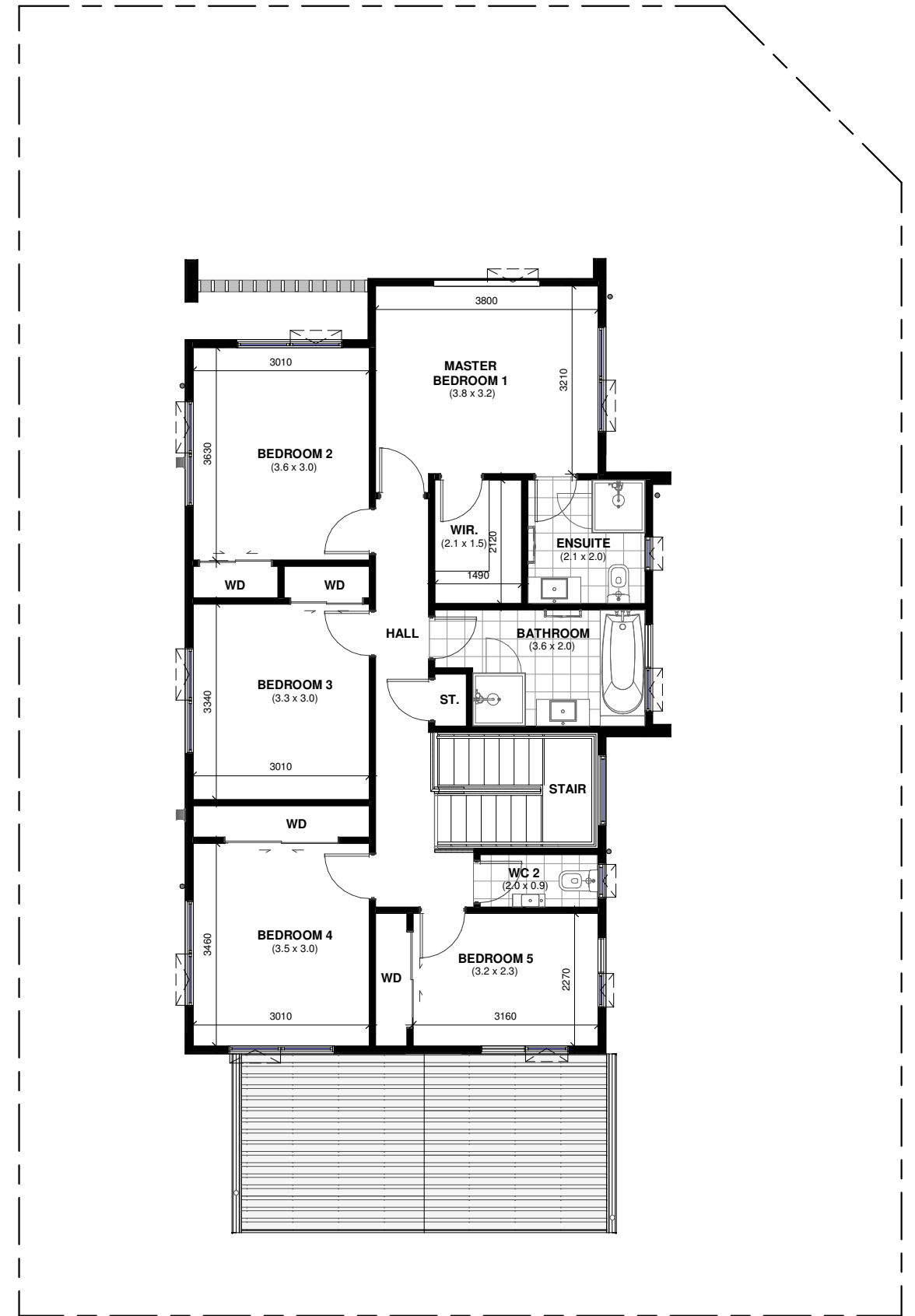
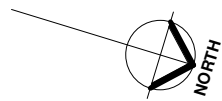
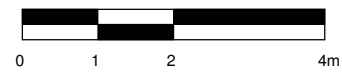

PLANS MAY BE SUBJECT TO CHANGE.  
FLOOR AREAS INDICATED IS APPROXIMATE ONLY



LOT 69 - NORTH ELEVATION

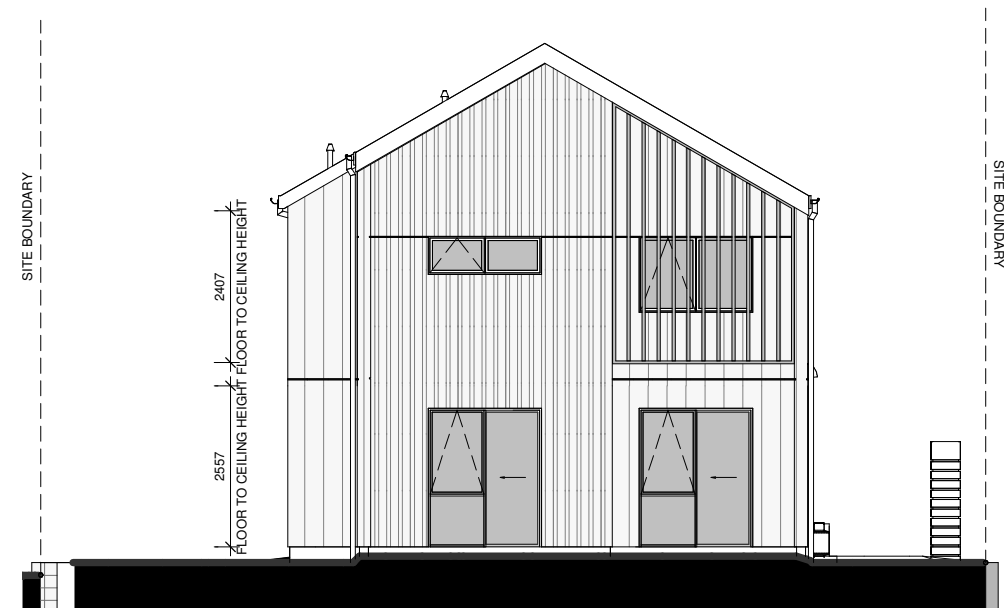

LOT 69 - WEST ELEVATION

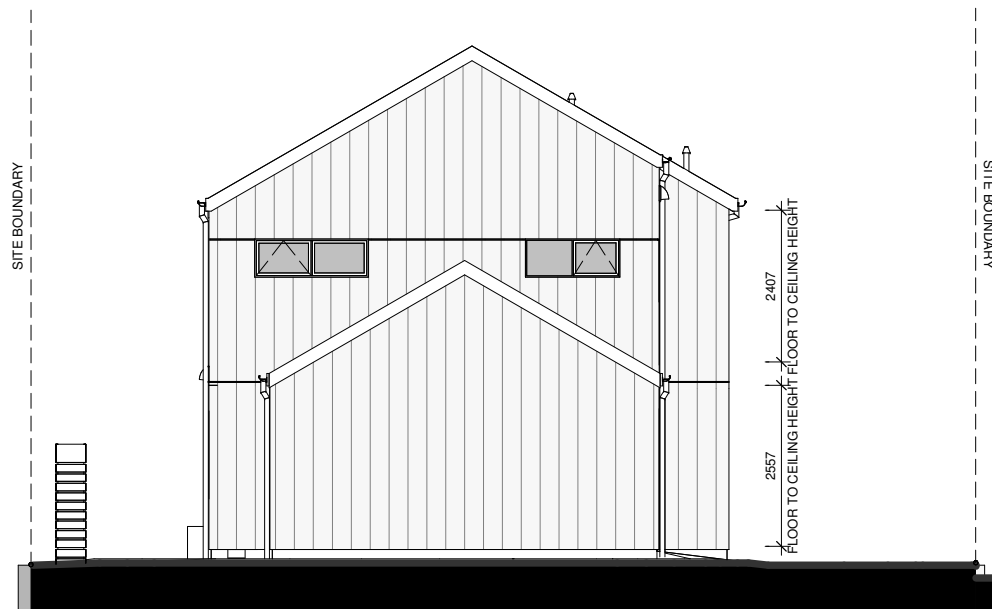

LOT 69 - EAST ELEVATION

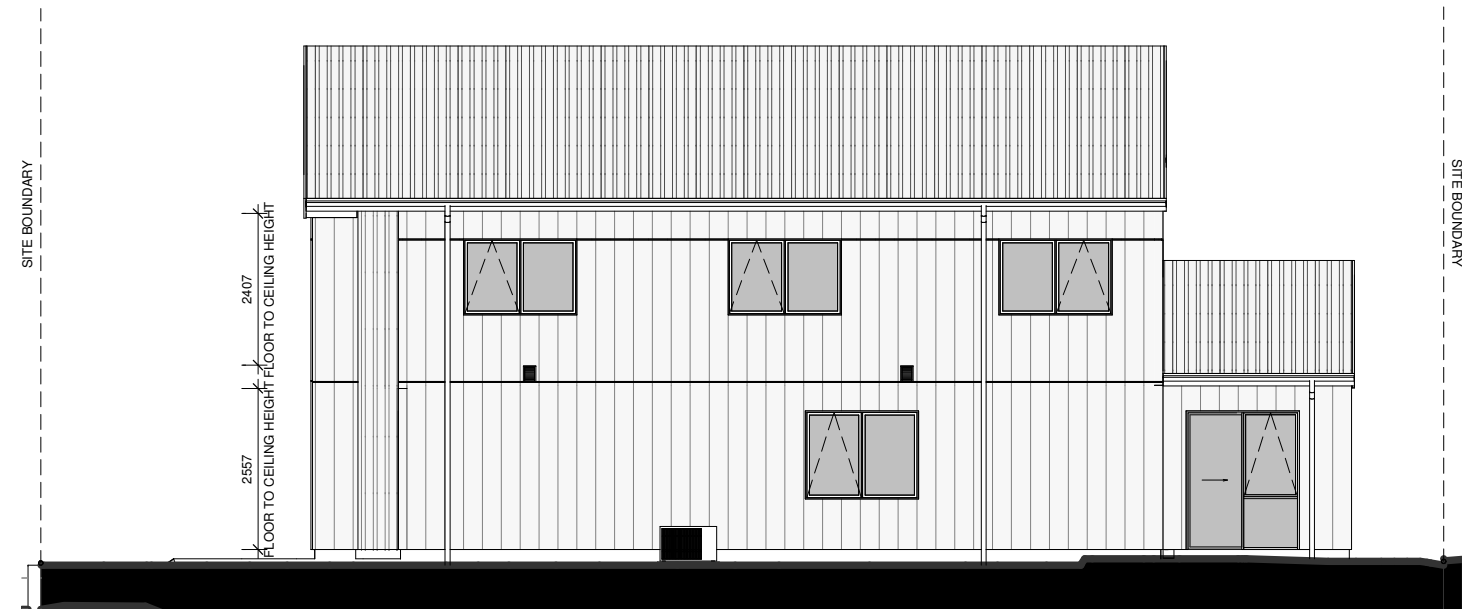

LOT 69 - SOUTH ELEVATION

**LOT 69**

24 PORT WAY, HINGAIA

PLANS MAY BE SUBJECT TO CHANGE.  
FLOOR AREAS INDICATED IS APPROXIMATE ONLY

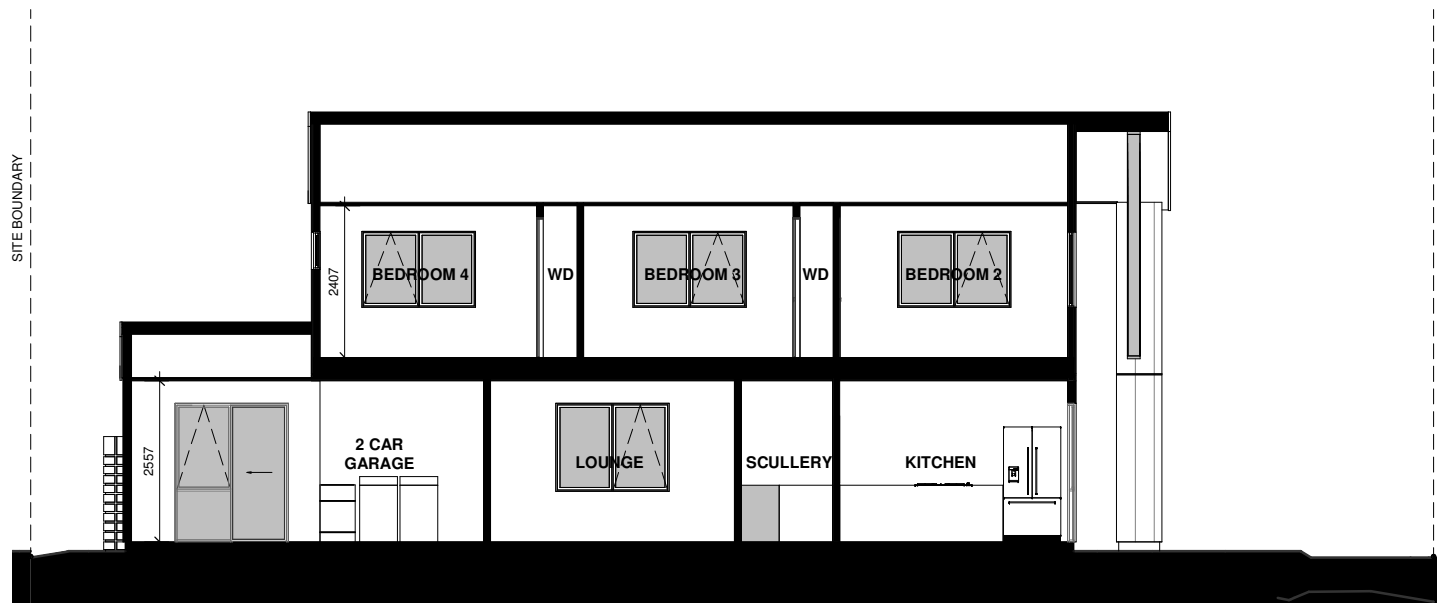

LOT 69 - SECTION A

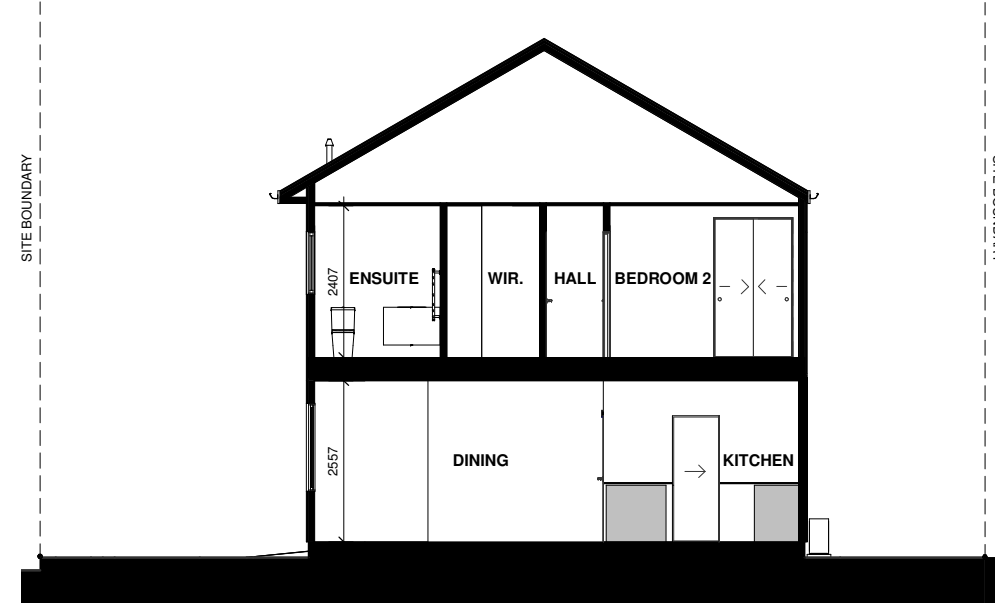

LOT 69 - SECTION C

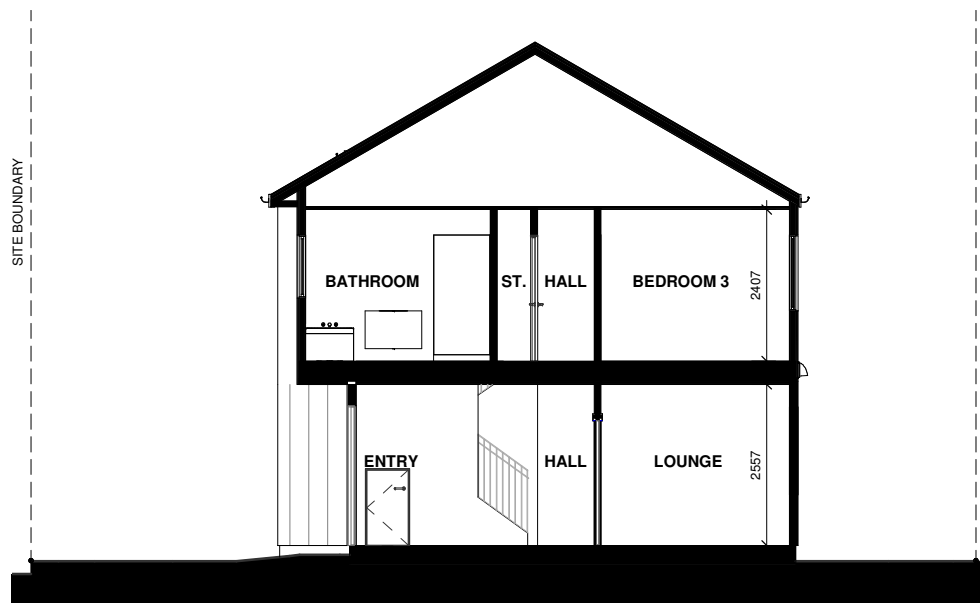

LOT 69 - SECTION D

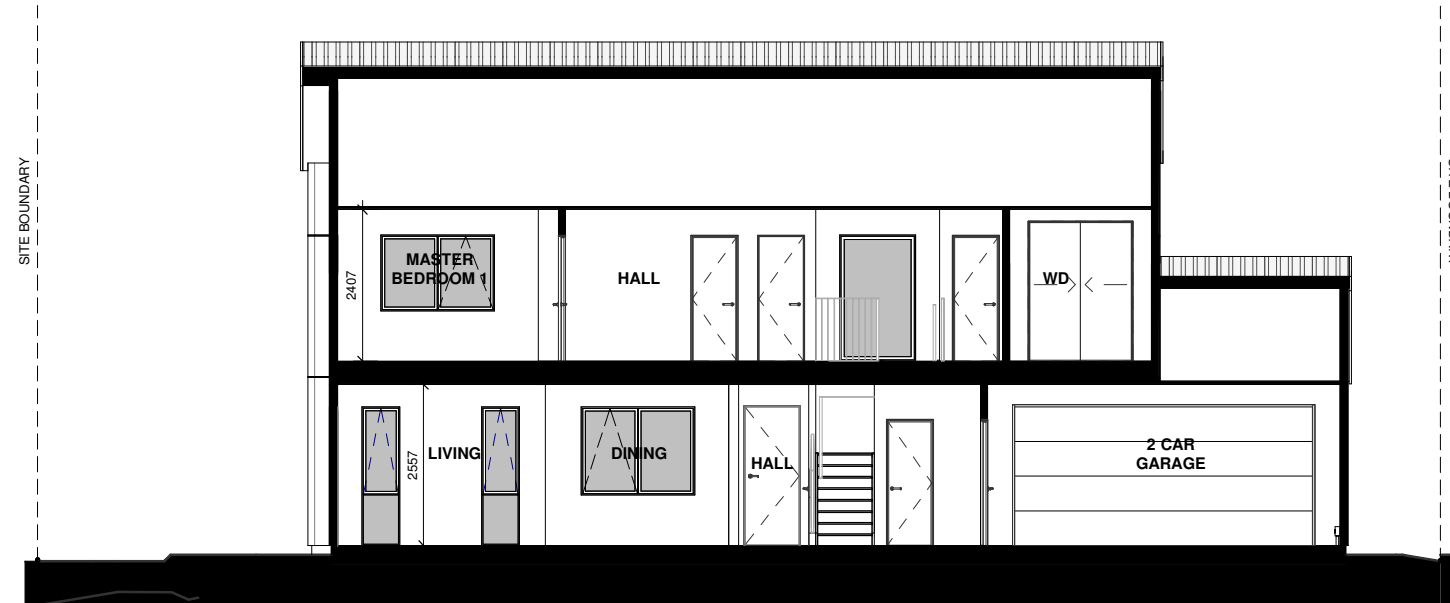

LOT 69 - SECTION B

**LOT 69**  
24 PORT WAY, HINGAIA

PLANS MAY BE SUBJECT TO CHANGE.  
FLOOR AREAS INDICATED IS APPROXIMATE ONLY

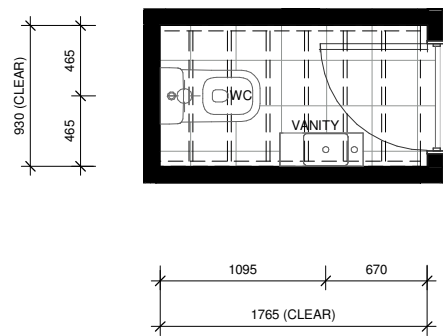

LOT 69 - GROUND FLOOR WC LAYOUT

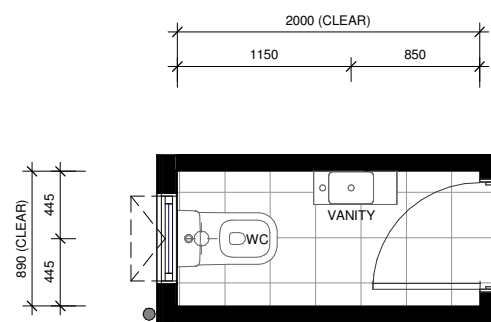

LOT 69 - FIRST FLOOR WC2 LAYOUT

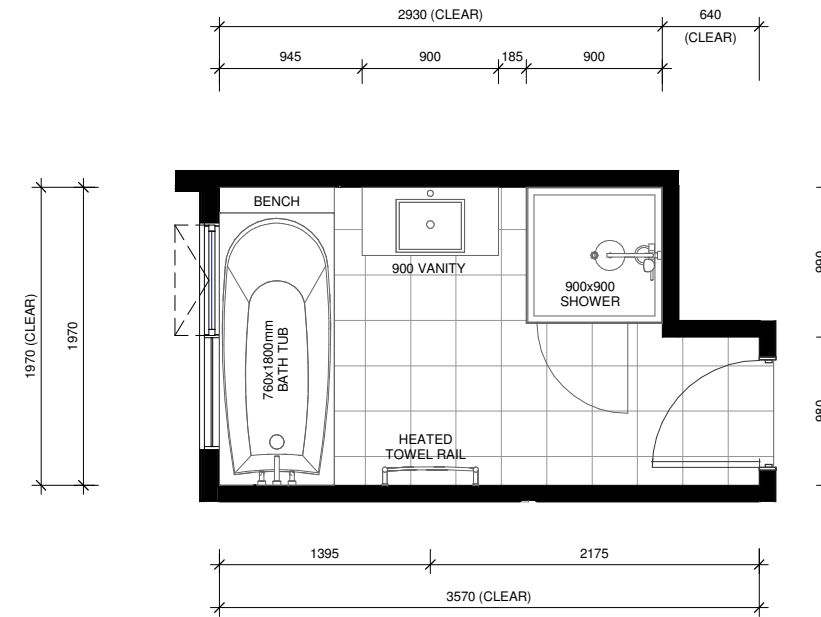

LOT 69 - FIRST FLOOR BATHROOM LAYOUT

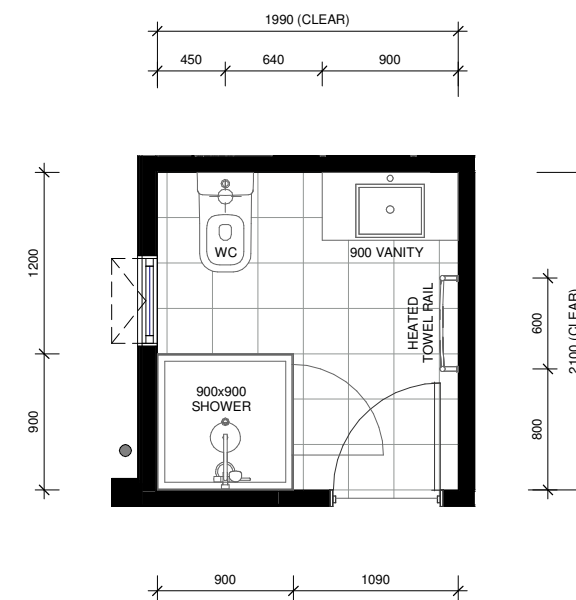

LOT 69 - FIRST FLOOR ENSUITE LAYOUT

**LOT 69**  
24 PORT WAY, HINGAIA

PLANS MAY BE SUBJECT TO CHANGE.  
FLOOR AREAS INDICATED IS APPROXIMATE ONLY